

Total Weight : 262g

PF980040

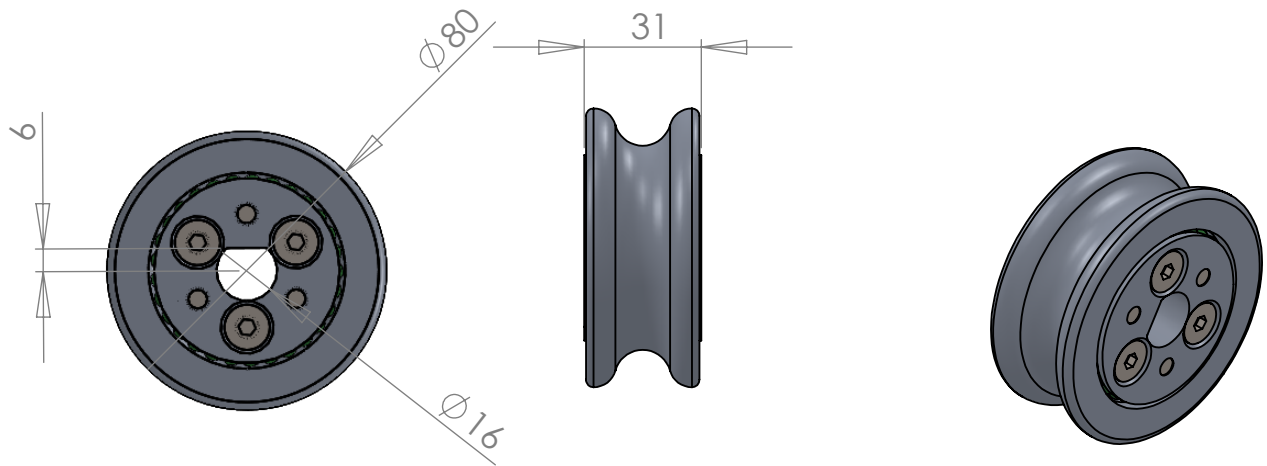

Total Weight : 265g

PF980040 [FP]

DATE	RECORD OF CHANGES	NAME	VISA	IND.	
MATERIAL		GENERAL TOLERANCES JS13js13		EVOLUTION OF DOCUMENT	
MECHANICAL PROPERTIES HEAT TREATMENT		SURFACE STATE Ra 1.6		Drawing by Q.L. WEIGHT SCALE	
FINISHING		PROTECTION		FOLIO	
ATTACHEMENT		ASSEMBLY		 www.karver-systems.com	
PART NAME KDS 40 sheave		KDS 40			
PRODUCT CODE K			PART NUMBER		FORMAT A4