

Balls-bearing block
Poulie à billes

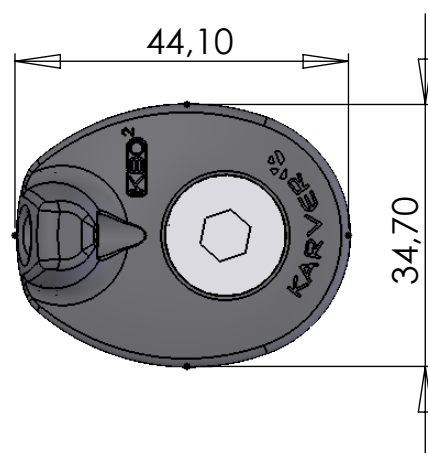

DATE	VERSION	MATERIAL	WEIGHT	SCALE
21/06/17	V1	Plastic / Aluminium	30g <i>Without crew/sans visserie</i>	1/1
MODEL KBO2FB		SAFE WORKING LOAD <i>CHARGE DE TRAVAIL</i> 220Kg	 www.karver-systems.com	
		BREAKING LOAD <i>CHARGE DE RUPTURE</i> _____		

PART NUMBER: PF790030[FB]

MORE INFOS ON WWW.KARVER-SYSTEMS.COM

FORMAT
A4